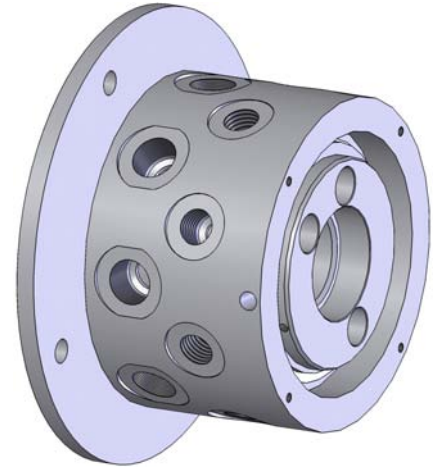
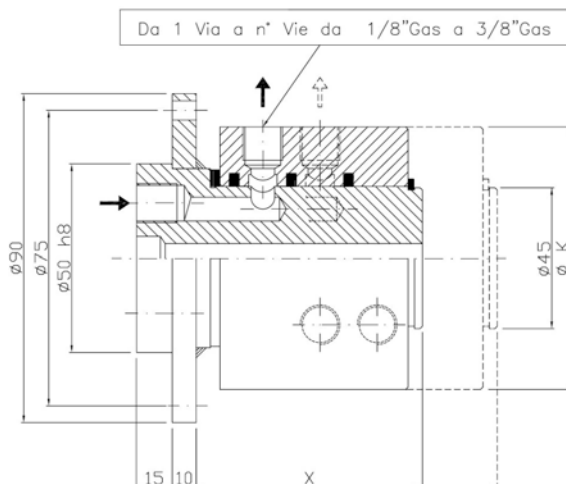

DATI DI FUNZIONAMENTO

- Fluidi di lavoro standard: olio idraulico, acqua, aria
- Pressione di esercizio: 350 bar
- Pressione massima: 400 bar
- Temperatura massima fluido: 90°C
- Temperatura min/max amb.: -20°C ÷ +60°C
- Max num. giri: 10 rpm
- Orientamento: Verticale
- Forze radiali e assiali: Non ammesse

CONFIGURAZIONI OPZIONALI

- Personalizzazione completa sul numero, tipologia e disposizione di passaggi fluidici
- Trascinamento tramite blocchetto, forature o flange
- Supporti tramite cuscinetti volventi

CARATTERISTICHE TECNICHE
D045

ENTRATA/USCITA	FILETTATI POSSIBILI
1/8"Gas	●
1/4"Gas	●
3/8"Gas	●
1/2"Gas	NO
3/4"Gas	NO
1"Gas	NO
1 1/4"Gas	NO
1 1/2"Gas	NO
2"Gas	NO

UTILIZZO	OLIO	ARIA	ACQUA
PRESS. MAX	250 bar	10 bar	10 bar
TEMP. MAX	80°C	80°C	80°C

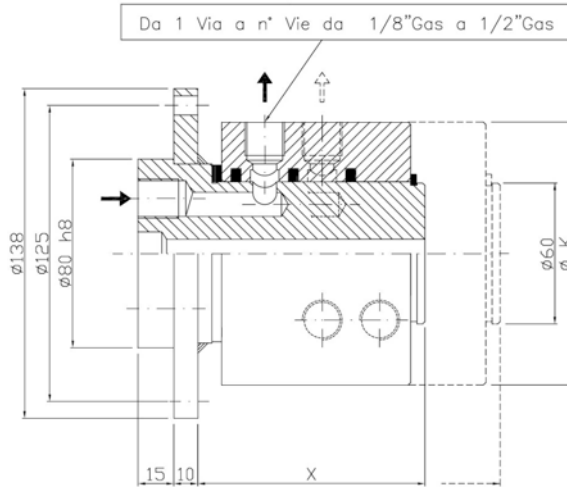
D060

ENTRATA/USCITA	FILETTATI POSSIBILI
1/8"Gas	●
1/4"Gas	●
3/8"Gas	●
1/2"Gas	●
3/4"Gas	NO
1"Gas	NO
1 1/4"Gas	NO
1 1/2"Gas	NO
2"Gas	NO

UTILIZZO	OLIO	ARIA	ACQUA
PRESS. MAX	250 bar	10 bar	10 bar
TEMP. MAX	80°C	80°C	80°C

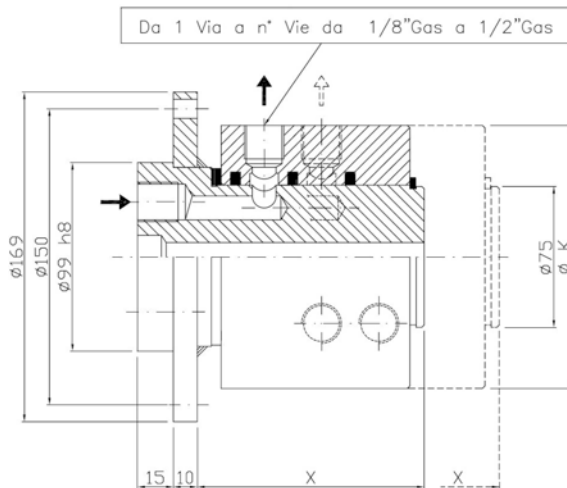
D075

ENTRATA/USCITA	FILETTATI POSSIBILI
1/8"Gas	●
1/4"Gas	●
3/8"Gas	●
1/2"Gas	●
3/4"Gas	NO
1"Gas	NO
1 1/4"Gas	NO
1 1/2"Gas	NO
2"Gas	NO

UTILIZZO	OLIO	ARIA	ACQUA
PRESS. MAX	250 bar	10 bar	10 bar
TEMP. MAX	80°C	80°C	80°C

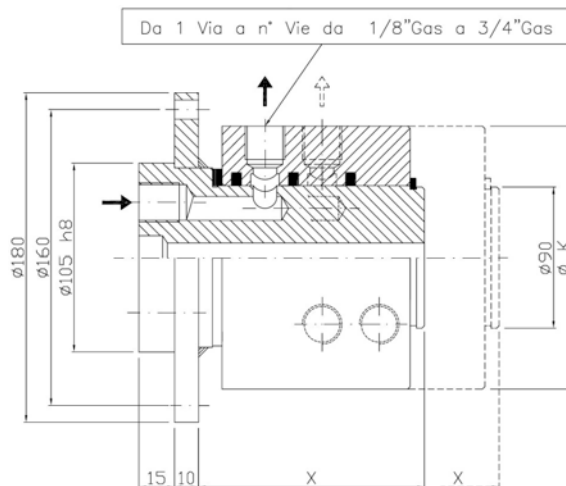
D090

ENTRATA/USCITA	FILETTATI POSSIBILI
1/8"Gas	●
1/4"Gas	●
3/8"Gas	●
1/2"Gas	●
3/4"Gas	●
1"Gas	NO
1 1/4"Gas	NO
1 1/2"Gas	NO
2"Gas	NO

UTILIZZO	OLIO	ARIA	ACQUA
PRESS. MAX	250 bar	10 bar	10 bar
TEMP. MAX	80°C	80°C	80°C

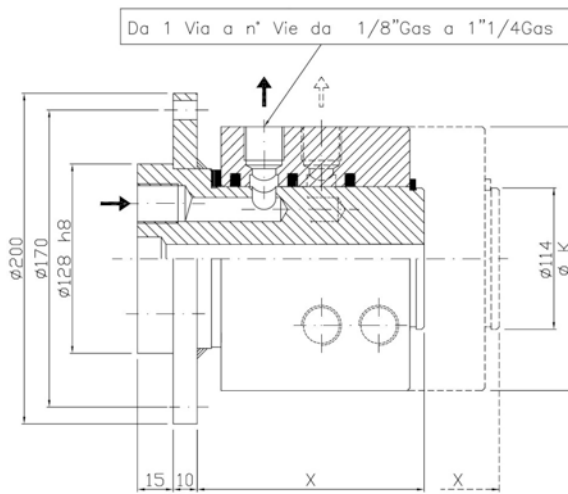
D0114

ENTRATA/USCITA	FILETTATI POSSIBILI
1/8"Gas	●
1/4"Gas	●
3/8"Gas	●
1/2"Gas	●
3/4"Gas	●
1"Gas	●
1"1/4Gas	●
1"1/2Gas	NO
2"Gas	NO

UTILIZZO	OLIO	ARIA	ACQUA
PRESS. MAX	250 bar	10 bar	10 bar
TEMP. MAX	80°C	80°C	80°C

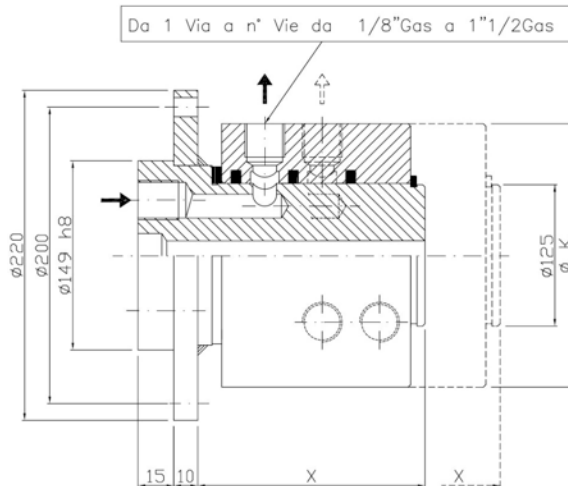
D0125

ENTRATA/USCITA	FILETTATI POSSIBILI
1/8"Gas	●
1/4"Gas	●
3/8"Gas	●
1/2"Gas	●
3/4"Gas	●
1"Gas	●
1"1/4Gas	●
1"1/2Gas	●
2"Gas	NO

UTILIZZO	OLIO	ARIA	ACQUA
PRESS. MAX	250 bar	10 bar	10 bar
TEMP. MAX	80°C	80°C	80°C

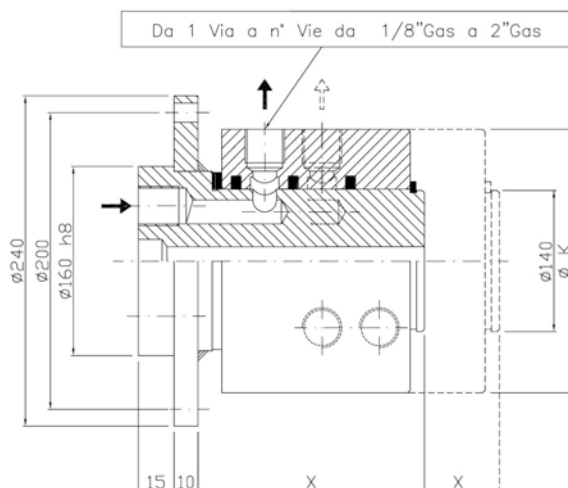
D0140

ENTRATA/USCITA	FILETTATI POSSIBILI
1/8"Gas	●
1/4"Gas	●
3/8"Gas	●
1/2"Gas	●
3/4"Gas	●
1"Gas	●
1"1/4Gas	●
1"1/2Gas	●
2"Gas	●

UTILIZZO	OLIO	ARIA	ACQUA
PRESS. MAX	250 bar	10 bar	10 bar
TEMP. MAX	80°C	80°C	80°C

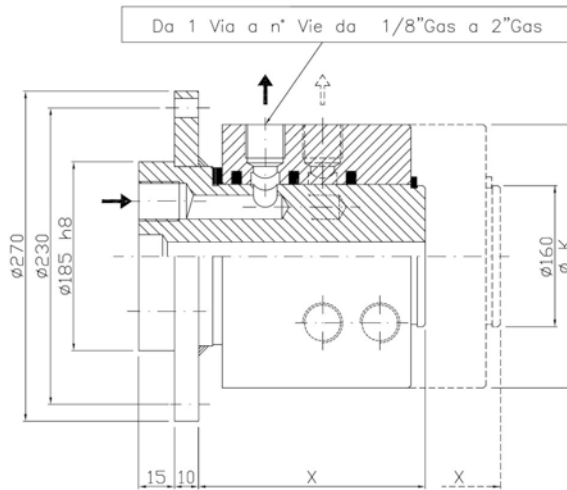
D0160

ENTRATA/USCITA	FILETTATI POSSIBILI
1/8"Gas	●
1/4"Gas	●
3/8"Gas	●
1/2"Gas	●
3/4"Gas	●
1"Gas	●
1 1/4"Gas	●
1 1/2"Gas	●
2"Gas	●

UTILIZZO	OLIO	ARIA	ACQUA
PRESS. MAX	250 bar	10 bar	10 bar
TEMP. MAX	80°C	80°C	80°C